

WIRELESS SYSTEM

INSTRUCTION MANUAL

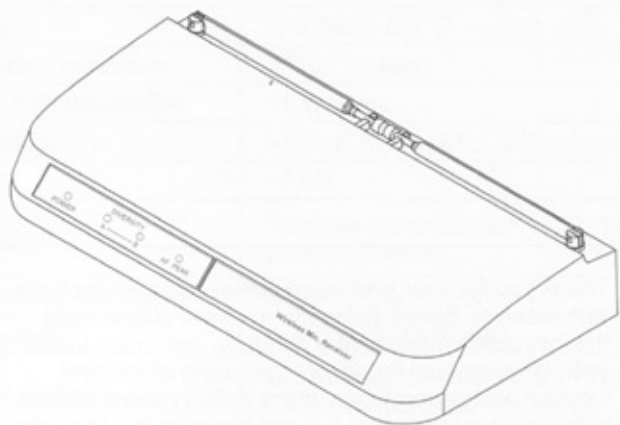

CONTENTS

CHARACTER	2
SPECIFICATIONS	2
NAMES OF PARTS	3
INSTALLATION	4
POWER SUPPLY CONNECTION	4
SQUELCH CONTROL AND VOLUME CONTROL	5
UNBAL OUT AND BALANLED OUT	6
INDICATOR ANDINSTALL ANTENNA	7
NOTE	8

Thank you for your kind using our wireless microphone with receiver. Before using the machine please read the instruction manual very carefully. According to our instruction manual for ensure you using of the best function and performance. If any defect please contact with our agent or dealer. It is our pleasure to serve you.

Thank you for your cooperation

Character :

- UHF band frequency by quartz locked controlled. Range from 780~960Mhz.
- Compact, lightweight, single-channel receiver.
- LED Indicator (Power , Diversity (A---B), Peak) and telescopic antenna.
- Compauder circuit for expanding dynamic range.
- Special circuit design to delete microphone switch ON/OFF noise.
- Audio output connect with XLR balanced and mono phone jack unbalanced.

Specifications :

Reception mode	Diversity model
Carrier Frequency Range	UHF 780~960 MHz
Oscillation Mode	Quartz controlled fixed frequency
Stabilite	$\pm 0.005\%$ /25° C
Deviation maximum	$\pm 40 / 50$ KHz
Portee de dynamique	>100 dBm
S/N proportion	>100dB At ± 15 KHz de Deviation
T.H.D.	<0.6%
Squelch	Tone Key (Tone frequency : 32.768KHz) External Control
Frequency Response	50Hz-15KHz ± 3 dB
Sensitivity	3uv pour 20dB SINAD
Audio Output	1. Unbalanced 6.3mm phone jack 750mV/5K Ω 2. XLR Balanced output 60mV/600 Ω
Power Supply	DC 12V-15V 300mA With AC/DC Adaptor
Dimensions	295(W) \times 114(D) \times 40(H) mm 0.97(W) \times 0.37(D) \times 0.13(H) pieds
Weight	550g 1.21 lb

NAME OF PARTS

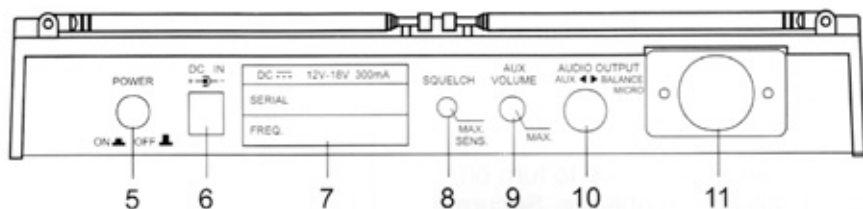

- | | |
|---------------------|-----------------------------|
| 5. Power Switch. | 9. Volume. Control. |
| 6. DC. Jacket. | 10. Audio output Connector. |
| 7. Frequency label. | 11. Balance Socket. |
| 8. Squelch Control. | |

1. Power Switch

Make sure the correct voltage. push this power switch once to turn on; If unit still fails to operate, Secure a qualified technician or contact us for a Return Authorization prior to Shipment.*Disconnect power supply before removing receiver cover.

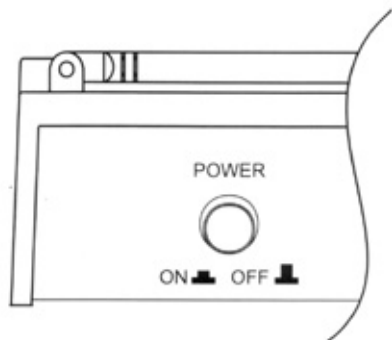

FIG.1

2. Power Supply Connection

Use DC power supply could switch with adaptor supply or batter of 12-18V DC.

Connection DC supply, DC plug connection with "DC-IN" socket. (see FIG2) another plug terminal connection with battery or power supply.

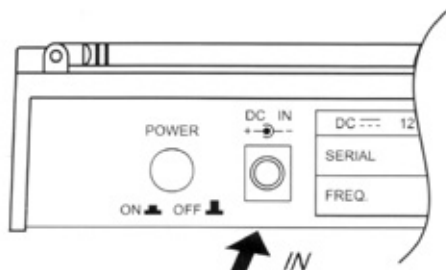
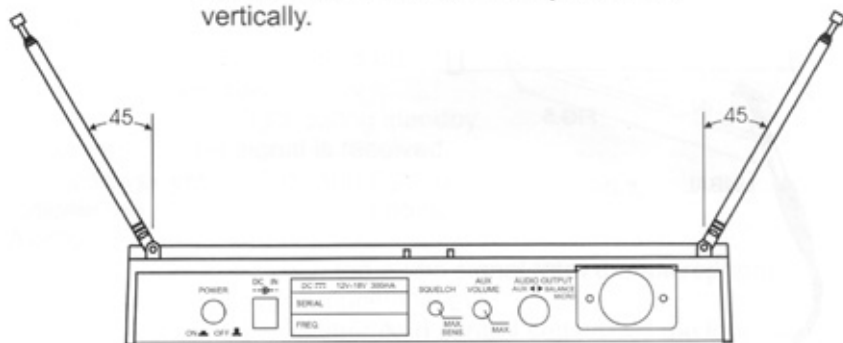

FIG.2

INSTRUCTION MANUAL

3. Install Antenna.

Receives signals from the transmitter.
Make sure the antenna is fully extended vertically.

**4. Volume Adjustor**

The purpose of this control is to give the ability to provide an audio output level from the wireless system that is similar to that of a wired microphone.



FIG.4

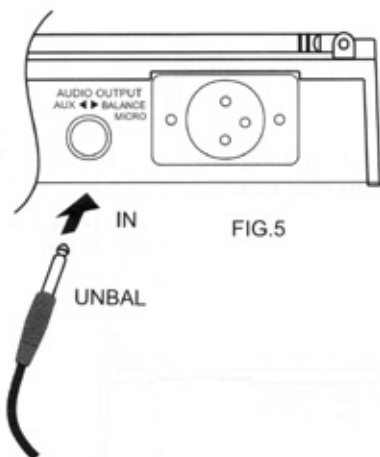

FIG.5

5. Audio Output Connector

You can connect an unbalanced audio cable with a 1/4 inch phone plug between this connector and your mixer or amplifier input.

6. Balance output XLR or CANNON Connection

Cable insert to balance socket output connecting with mixer or amplifier MIKE IN.

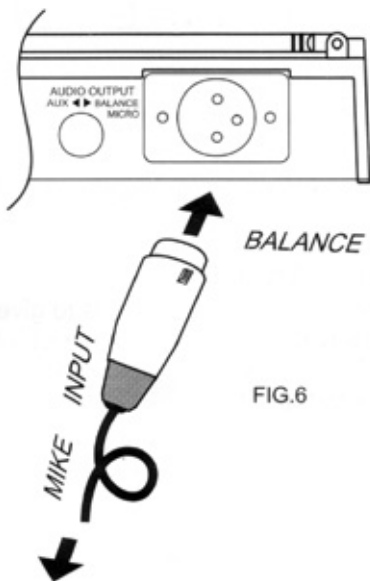

FIG.6

INSTRUCTION MANUAL

7. Indicator

a. Power ON Indicator:

This red light glows when the DC supply and power switch are ON. It indicates that the receiver is on.

b. Reception Indicator:

This indicator does light during standby. When microphone signal is received, the green or yellow indicator light indicates the reception of microphone.

c. Audio peak Indicator:

This red light flickers when the audio signal from the microphone approaches the overload clipping level. It is affected by the transmitter gain control setting and the loudness of your voice.

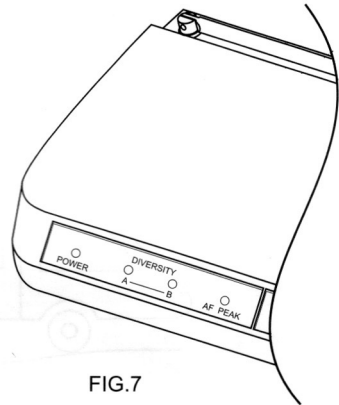

FIG.7

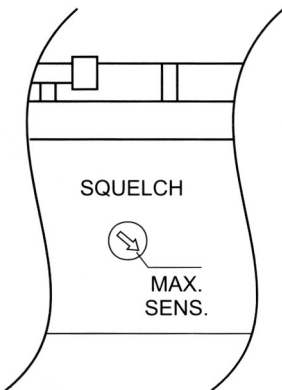

FIG.8

8. Squelch Control

This control is factory present, SQ noisy controlled adjustment, Before you turn-on the receiver, at first. The receiver already have been jamming by outside signal. Please adjust SQ control until the jamming signal has disappeared. (clock-wise)



IF YOU ARE NOT TECHNICAL
ENGINEER PLS. DO NOT
MODIFIED OR KNOCK - DOWN
IT.

RECEPTEUR :

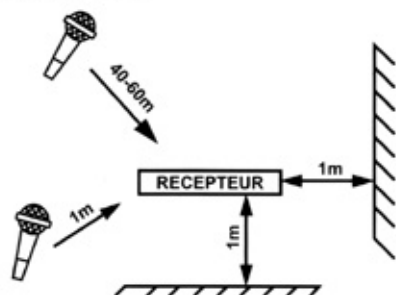

THE WIRELESS RECEIVER
LOCATED AT GOOD CONDITION
PLACE.



BE CAREFUL, DON'T DROP
OFF THE MICROPHONE TO
FLOOR.

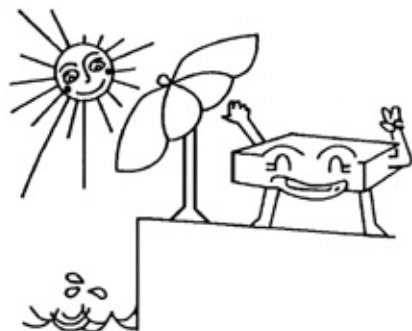

KEEP AWAY RAINING OR
SUN SHINE.

Having been devoted to R&D for years, our company is specialized in manufacturing high quality professional wireless microphones. This really elaborated model serves to your complete satisfaction on many occasions karaoke, family and friend gathering.

Feature:

Transmitter of SMT with high-end quality and technology, advanced skills to make the construction more convenient to analyze capsule, module of transmitter.

SPECIFICATION:

	PERFORMANCE SPECIFICATION
Carrier Frequency Range	UHF 780-960 Mhz
Microphone Element	Dynamic Microphone
Oscillation Mode	Quartz controlled fixed frequency
Modulation mode	FM (F3E)
Antenna	Built-in
RF Carrier Power	10mW (may be adjusted based on regulation)
Effective Radiated Power (Spurious)	Less than 2mW
Tone Frequency	32.768KHz
Pre-Emphasis	50uS
Current Drain	35mA Typical(9.0V)
Battery	More than 8 hours (Alkaline)
Dimensions	246mm/9.69(H)*
Weight	Approx. 0.21kg/0.46(lb)

(HAND HOLD MICROPHONE TRANSMITTER)

SMT is design of high quality and precise technology. High quality dynamic cartridge is used to produces HI-FI sound, which is soft, broad and deep, most suitable for KTV entertaining.

OTHER FEATURES:

- "STAND-BY" function.
- Steel net based to prevent from rolling.

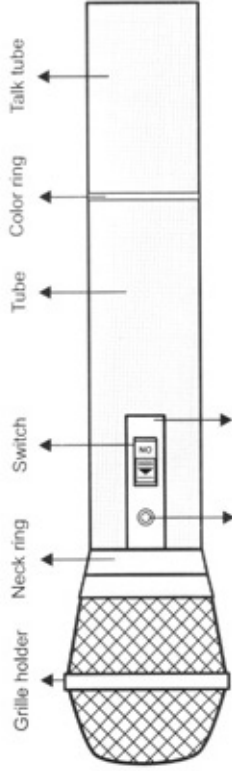

Power LED light Switch cover

BATTERY INFORMATION:

NOTE :

Make sure the power switch is in the "OFF" position when changing or installing new battery. Average life on an alkaline battery is 6-8 hours. Be sure to use good quality long life 9V alkaline battery only.

1. This microphone has a 3-level power switch design.
2. In using first turn on the receiver and then the transmitter.
3. New battery the power light is in "OFF".
The light is "ON". It indicates the battery needs to be replaced.
4. Remember to turn the switch "OFF". When the microphone is not in use in order to save power. In "STAND-BY" set the switch to the center.

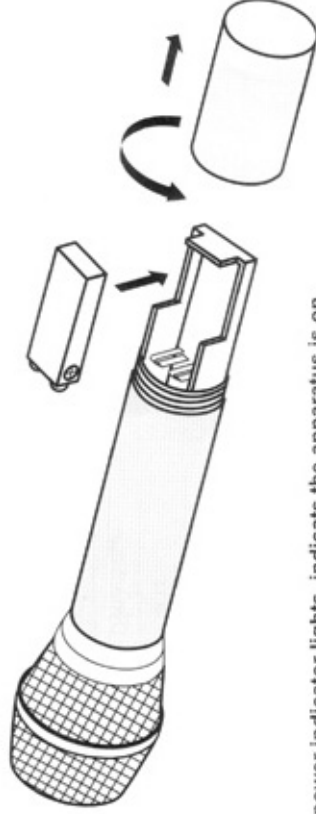

When switches the **POWER** switch to "ON" position ,then the power indicator lights ,indicates the apparatus is on.
When switches the **POWER** switch to "OFF" position ,then the power indicator exindicates the apparatus is off.