



DT71 Mini Digital Tweezers

User Manual V1.05



Thank you for purchasing DT71 Mini Digital Tweezers.
Please read this manual before using the device.
This user manual is based on APP1.05.

目录

• Safety Statements	1
• Product Introduction	2
• Installation And Charging	4
• Measure	8
• Signal Output	11
• Calibration	12
• Config File	13
• Firmware Upgrade	15
• Standard Service	15
• Legal Statements	16



Safety Statement

Read carefully all the following safety precautions to avoid personal injuries and prevent damage to the device or any products connected to it. Failure to follow these safety instructions could result in personal injuries or risk of fire.

1. Please use only the power cable dedicated for this product or certified by your country/region.
2. Before connecting and disconnecting DT71's tips to device under test, please power off the circuit to be tested, and after connecting DT71's tips correctly, power on and measure the circuit.
3. It is recommended to unplug the controller when DT71 is not in use.
4. To avoid fire or electric shock, please observe all terminal ratings and marking instructions to avoid damage to the device. Before connecting DT71, please consult the product manual or product label for information about the rated values;
5. After the power is turned on, do not touch the exposed connectors and components. Do not use it when you suspect that the product is malfunctioning. Please contact after-sales service for testing, maintenance, adjustment or parts replacement;
6. Static electricity can cause damage to DT71, and measure should be made in anti-static areas if possible. Before connecting DT71 to the device under test, the inner and outer conductors should be grounded briefly to discharge static electricity.
7. Please keep DT71 surface clean and dry; do not operate in humid, flammable and explosive environment.



Warnings:

Please do not disassemble DT71 controller or test arms. Once disassembled, it cannot be repaired!



Liability Statement:

Any damage of the product or losses related to the product damage, if it's man-caused, or assumed to be man-caused, the liability will belong to the user. The user is responsible for any damage or loss caused by unauthorized disassembly or modification of the product.

Product Introduction





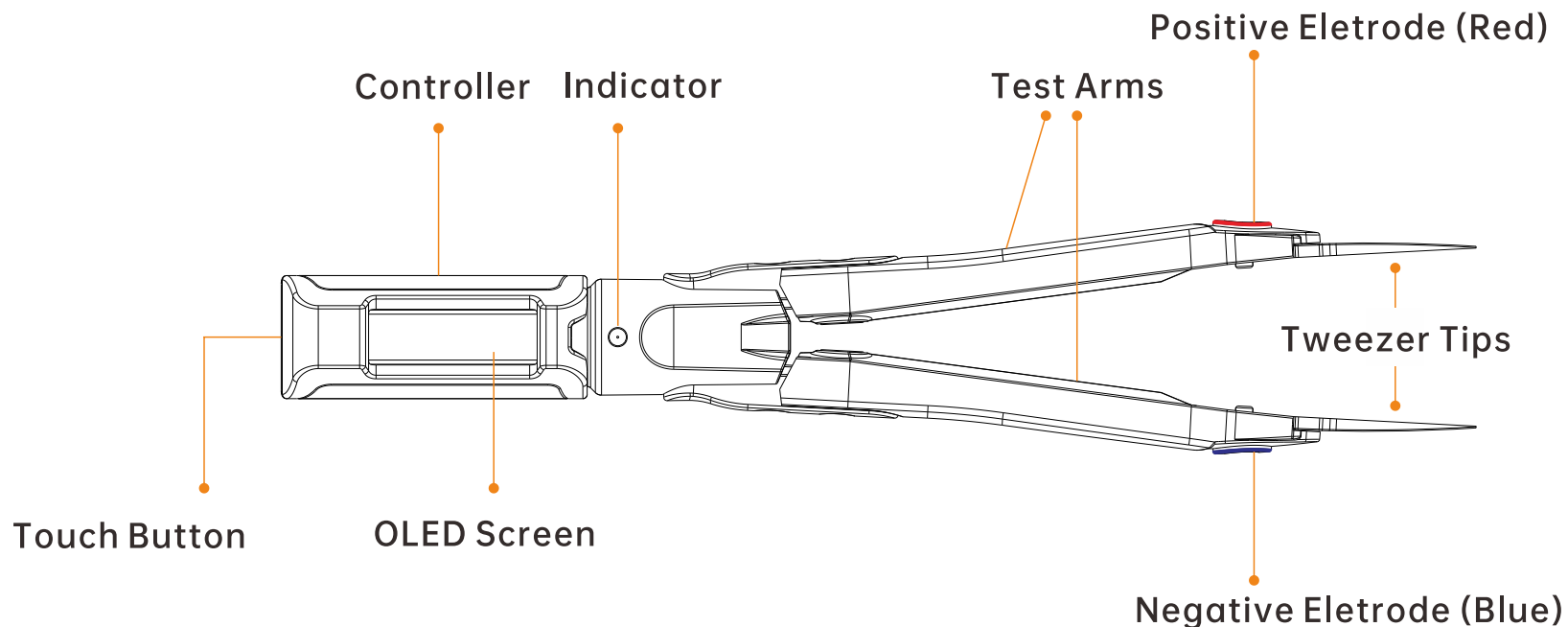

DT71 Mini Digital Tweezers is a multi-function measure tool with a fully differential input and built-in signal generator. DT71 has a unique ternary structure, which can be split into a controller, test arms and tweezer tips, flexible in replacement and combination. DT71 uses thickened gold-plated tweezer tips, which can be replaced according to the application scenario. It can measure various devices such as resistor, capacitor, inductor, voltage, frequency, diode, etc. to help users quickly identify components. The built-in micro signal generator of DT71 can output a variety of signals, providing a perfect solution for the debugging and maintenance of complex electronic systems and the classification and detection of discrete chip components.

>> Appearance



>> Introduction

DT71 Mini Digital Tweezers is a new concept portable LCR tester, which can automatically identify the type of electronic components and actively select the appropriate range for measure; the built-in signal generator can output a variety of required signals for electronic system debugging and maintenance.

-  7 measurement types: resistance, inductance, capacitance, voltage, frequency, diode
-  Controller can be rotated 360°, providing different viewing angles
-  Automatic identification of components, Measure primary and secondary parameters
-  Smart Recognition, automatically recognize left and right hand mode
-  Micro signal generator
-  Sleep mode, pick up to wake up

>> Parameters

Power interface		3.5mm audio
Size	Controller	47mm
	Test arms	106mm
Weight		22g
Working temperature		10~50°C
Working humidity		10~90%RH
Charging time		2 hours
Operation time		10 hours (in continuous use)

Installation And Charging

>> Installation

(1) Fully insert the 3.5mm audio plug of DT71 controller into the socket of the test arms. After the correct insertion, the screen will display the bootup icon and firmware version, and then enter user interface;

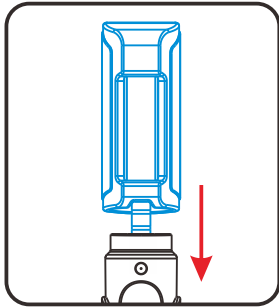

Display

	Bootup icon
Ver1.XX	Firmware version

(2) Tap the touch button to select measure mode for use.

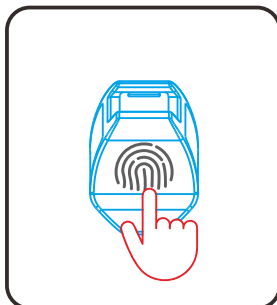

Display

M: Measure mode
A: Automatic identification mode

Measurement type

Vx: --- Measure result

M

>> Button and menu

DT71 has no physical buttons, only a hidden touch button on the top of the controller. Users can switch functions and modes by tapping the touch button.

Operating		Function
	Long press	Switch submenu of measure/automatic identification/signal generator/calibration mode
	Single tap	Switch menu options

Menu:

Submenu	Menu Definition	Options	Options Definition	Measuring Range
Measure	Measure mode; default	Rx:---	Resistance	0.1Ω~2MΩ
		Dx:---	Diode	0.1V~3V
		Cx:---	Capacitance	0.1pF~400uF
		Lx:---	Inductance	1uH~50mH
		Fx:---	Frequency	10HZ~20MHZ
		Vx:---	Voltage	1mV~40V

Submenu	Menu Definition	Options	Options Definition	Measuring Range
Identify	Automatic identification mode		Screen will display "A" on lower left corner; Can automatically measure resistance/ inductance/capacitance /Diode	
Signal Gen	Signal generator mode	SINE 10KHz	Output sine wave, default 10KHz	For frequency modification options, see configuration file description P13
		NOISE 100KHz	Output noise wave, default 100KHz	
		USER 2KHz	Output user-defined wave, default 2KHz	
		PULSE 10KHz	Output pulse wave, default 10KHz	
Calibration	Calibration mode	Calibration #0 Close Tips Pls!	Closed (short-circuit) tweezer tips	Please refer to P12
		Calibration #1 Open Tips Pls!	Open (open-circuit) the tweezer tips	

» How to charge

Insert the 3.5mm male plug of the dedicated data cable into DT71's test arms, and then connect a DC5V power supply to charge the test arms. The charging indicator light is always on when charging, and off when fully charged.

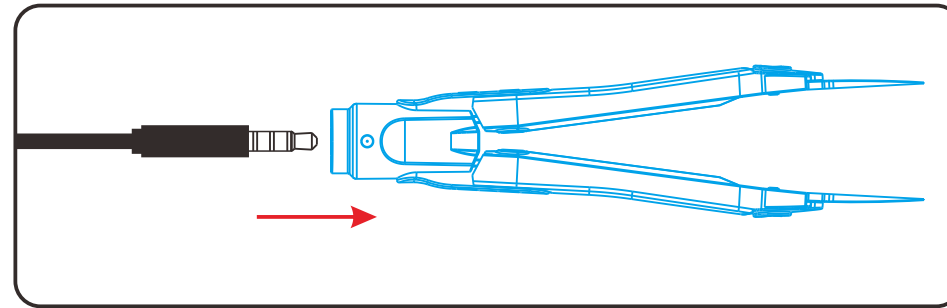

» Automatic sleep and wake up

DT71 has automatic sleep function, when DT71 remains static for 60 seconds (factory setting), it will automatically enter sleep mode; When you need to use it again, close (short-circuit) the tweezer tips to wake up DT71 to enter user interface.

Preparation before measuring

Before measuring, please connect DT71 controller to test arms, or short-circuit the tweezer tips to wake up DT71. When the screen displays, select the correct measure mode to start measuring.

Measure parameters and accuracy:

Measure Type	R		D	C		L		F		V	
	Resistance		Diode	Capacitance		Inductance		Frequency		Voltage	
Range	0.1Ω~1000Ω	1KΩ~2000KΩ	0.1V~3V	0.1pF~1000pF	0.001uF~400uF	1uH~1000uH	1mH~50mH	10Hz~1000Hz	1kHz~2000KHz	1mV~100mV	0.1V~40V
Resolution	0.1Ω	1KΩ	0.1V	0.1pF	0.001uF	1uH	1mH	10Hz	1KHz	1mV	0.1V
Accuracy	0.5%+2	0.5%+2	1%	2%+3	2%+3	5%+3	5%+3	0.1%+3	0.1%+3	2%+5	1%+3

The test data comes from laboratory environment and is for reference only.
 True error range=±(reading*accuracy + corresponding resolution*value)

 Note: Maximum absolute input voltage: -5V ~ 50V; Input resistance: 1MΩ.

>> Manual Measure Mode

● Resistance

M Rx: ---

- 1) Tap DT71's touch button to switch to resistance measure mode;
- 2) Clamp tweezer tips in the two poles of resistance;
- 3) The screen will display the resistance value.

● Frequency

M Fx: ---

- 1) Tap DT71's touch button to switch to frequency measure mode;
- 2) The positive electrode (red) of the tweezer tips connects to the signal positive, and the negative electrode (blue) to the signal ground;
- 3) The screen will display the frequency value.

● Inductance

M Lx: ---

- 1) Tap DT71's touch button to switch to inductance measure mode;
- 2) Clamp tweezer tips in the two poles of inductance;
- 3) The screen will display the inductance value.

● Capacitance

M Cx: ---

- 1) Tap DT71's touch button to switch to capacitance measure mode;
- 2) Clamp tweezer tips in the two poles of capacitance;
- 3) The screen will display the capacitance value.



● Diode

M Dx: ---

- 1) Tap DT71's touch button to switch to diode measure mode;
- 2) Clamp tweezer tips in the two poles of diode. The positive electrode (red) of the tweezer tips to the positive of the diode, and the negative electrode (blue) of the tweezer tips to the negative of the diode;
- 3) The screen will show the diode forward voltage drop.

● Voltage

M Vx: ---

- 1) Tap DT71's touch button to switch to voltage measure mode;
- 2) The positive electrode (red) of the tweezer tips connects to the high potential, and the negative electrode (blue) to the low potential;
- 3) The screen will display the voltage value.
 The screen will display "Negativ" if the positive and negative tips of the DT71 are reversed. Please adjust and measure again.
 When the measured object is powered on, DO NOT insert or remove DT71controller.

>> Automatic Identification Mode

A 10uH 1Ω

Primary Secondary parameter

- 1) Long press DT71's touch button to switch to automatic identification mode (Identify); DT71 can automatically identify inductor, capacitor, resistor, diode;
- 2) The screen will display the primary parameters and secondary parameters of the measured object.

Signal Output

Signal output types:

Type	SINE	NOISE	USER	PULSE
	Sine Wave	Noise Wave	User-defined Wave	Pulse Wave
Frequency	For frequency modification options, see configuration file description P13			

>> Signal Generator

SINE 10KHz

- 1) Long press DT71's touch button to switch to signal generator mode (Signal Gen);
- 2) Tap the touch button to switch sine wave/noise wave/user-defined wave/pulse wave.

>> User-Defined Wave

USER 100KHz

- 1) Tap DT71's touch button to switch to "USER" signal output;
- 2) The output waveform can be defined in the DFU configuration file, please refer to P14.

Calibration

» Zero Calibration

1. Long press DT71's touch button to switch to calibration mode (Calibration);
 2. Keep the tweezer tips closed and short circuit until the screen prompts the next step;
 3. Open the tweezer tips and keep it open until the screen prompts the next step;
 4. After the open calibration is successful, the screen will prompt whether to save the calibration data, tap the touch button to confirm and save.
- * If you mistakenly enter calibration mode, long press the touch button to exit.

Calibration #0
Close Tips Pls!

Calibration #1
Open Tips Pls!

» Accurate Calibration

For accurate calibration, please visit www.miniware.com.cn and download the DT71 calibration accessories, and operate according to the instructions.

Config File

Insert DT71 controller into the Data Cable's 3.5mm female socket, connect the Data Cable to your PC via USB Type-C cable; a 8-character string removable hard disk will appear on your PC. Open the CAL.INI configuration file in the removable disk and set the parameters.

>> Parameter Setting

Parameter	Definition	Setting Range
SLEEP_TIME=60	Sleep time	30~999 (Second)
DISPLAY_DIRECTION=4	Left/Right hand mode	0: Right hand mode, 3: Left hand mode 4: Automatic recognition
OLED_BRIGHTNESS=2	Display brightness	0~10
SINE_FREQ_OPT=0	Sine wave signal frequency parameters	0:10KHz, 1:5KHz, 2:2KHz, 3:1KHz, 4:500Hz, 5:200Hz
NOISE_FREQ_OPT=1	Noise signal frequency parameter	Currently the noise signal only supports 100KHz
USER_FREQ_OPT=2	User-defined signal frequency parameters	0:10KHz, 1:5KHz, 2:2KHz, 3:1KHz, 4:500Hz, 5:200Hz
PUSLE_FREQ_OPT=3	Pulse signal frequency selection parameter	0:100KHz, 1:50KHz, 2:20KHz, 3:10KHz, 4:5KHz, 5:2KHz, 6:1KHz, 7:500Hz, 8:200Hz

» Restore Factory Setting

Open the CAL.INI config file, delete all data, enter "load default" and save it to restore the factory settings.

» User-Defined Wave Setting

```
USER_WAVEFORM = {  
0x7FF, 0x87F, 0x8FF, 0x97E, 0x9FC, 0xA77, 0xAF0, 0xB66, 0xBD9, 0xC48,  
0xCB2, 0xD18, 0xD78, 0xDD3, 0xE29, 0xE77, 0xEC0, 0xF01, 0xF3C, 0xF6F,  
0xF9A, 0xFBE, 0xFDA, 0xFEE, 0xFFA, 0xFFE, 0xFFA, 0xFEE, 0xFDA, 0xFBE,  
0xF9A, 0xF6F, 0xF3C, 0xF01, 0xEC0, 0xE77, 0xE29, 0xDD3, 0xD78, 0xD18,  
0xCB2, 0xC48, 0xBD9, 0xB66, 0xAF0, 0xA77, 0x9FC, 0x97E, 0x8FF, 0x87F,  
0x7FE, 0x77E, 0x6FE, 0x67F, 0x601, 0x586, 0x50D, 0x496, 0x424, 0x3B5,  
0x34B, 0x2E5, 0x285, 0x22A, 0x1D4, 0x186, 0x13D, 0x0FC, 0x0C1, 0x08E,  
0x063, 0x03F, 0x023, 0x00F, 0x003, 0x000, 0x003, 0x00F, 0x023, 0x03F,  
0x063, 0x08E, 0x0C1, 0x0FC, 0x13D, 0x186, 0x1D5, 0x22A, 0x285, 0x2E5,  
0x34B, 0x3B5, 0x424, 0x497, 0x50D, 0x586, 0x601, 0x67F, 0x6FE, 0x77E,  
0x000, 0x000, 0x000, 0x000, 0x000, 0x000, 0x000, 0x000, 0x000, 0x000,  
0x000, 0x000, 0x000, 0x000, 0x000, 0x000, 0x000, 0x000, 0x000, 0x000,  
0x000, 0x000, 0x000, 0x000, 0x000, 0x000, 0x000, 0x000, }
```

Note:

- 1) Use hexadecimal number 0x000~0xFFF to represent 0~3V signal waveform;
- 2) The output waveform only loads the first 100 points of valid data; red font modification is invalid.

Firmware Upgrade

- 1) Visit www.miniware.com.cn to download the latest DT71 firmware to your PC.
- 2) Insert DT71 controller into the Data Cable's 3.5mm female socket, connect the Data Cable to your PC via USB Type-C cable; a 8-character string removable hard disk will appear on your PC, entering DFU setting mode.
- 3) Copy the .hex firmware to the root directory of that disk. After the extension of the firmware changes from ".hex" to ".rdy", restart DT71, thus the firmware is upgraded.

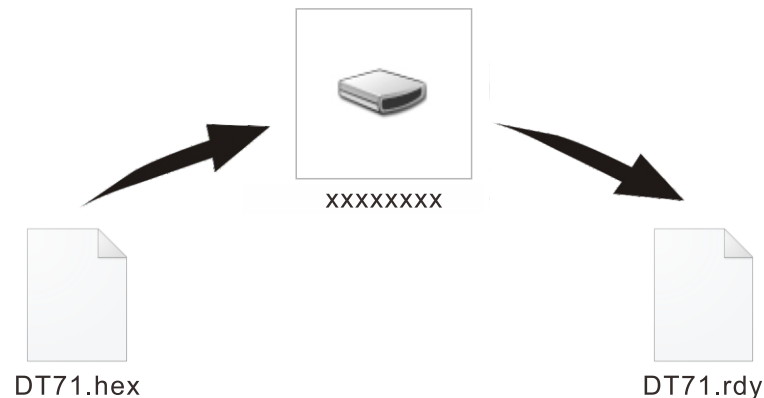

Standard Service

One year of free warranty will be provided, if the damage was not caused by false manipulation by the user. Please contact your seller for warranty details. Tweezer tips are consumables products, once it's used, no replacement will be provided.

Legal Statements

Disposal



Do not dispose this product with domestic waste.

- This device complies with the WEEE Directive (this additional product label indicates that this electronic product must not be disposed of in household waste).
- Handling and recycle: Disposal of the product shall be manipulated according to laws and regulations in your area.

Statement of fulfilling FCC standard



This device fulfills part 15 of the FCC regulations. Device must fulfill below 2 conditions:

- (1) Device must not generate interference;
- (2) Device must be able to resist any interferences on it, including interferences that could cause dangerous manipulation.

Statement of fulfilling CE standard



This product with CE logo on it fulfills related Euro Union laws and regulations.